

Frame

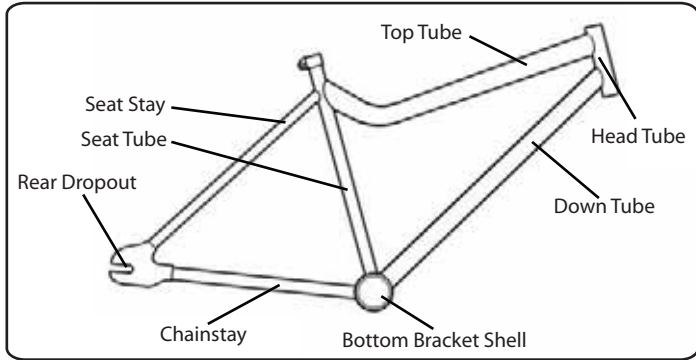

Fork

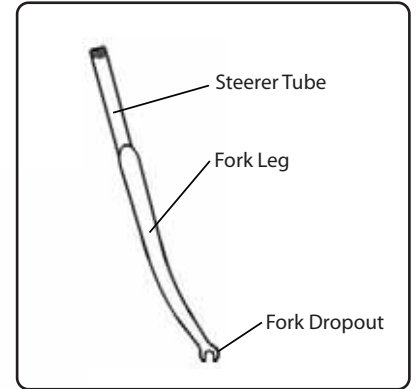

Tire

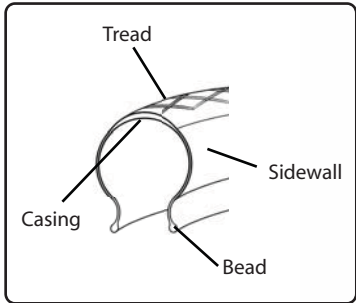

Spoke

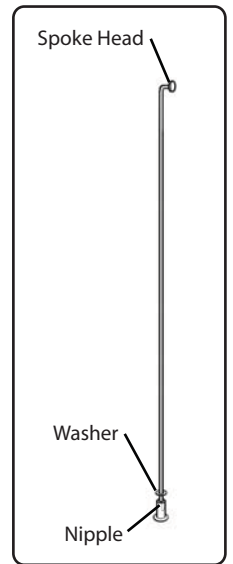

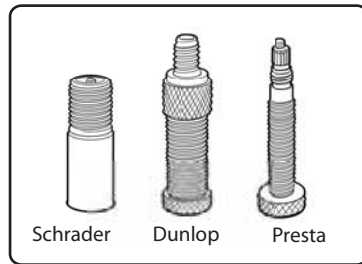

Valve Types

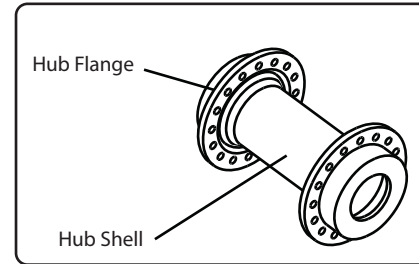

Hub

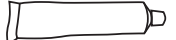

	Tire Lever
	Hacksaw Blade
	Cutting Tool
	Patching Glue

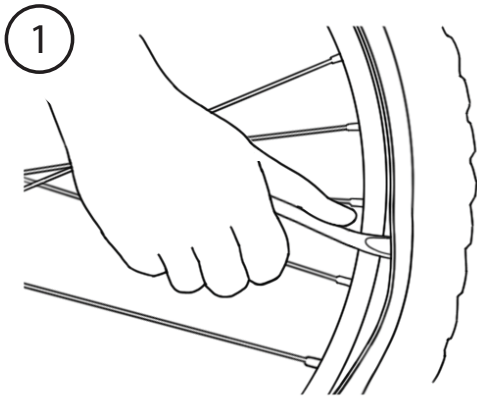

Remove tube

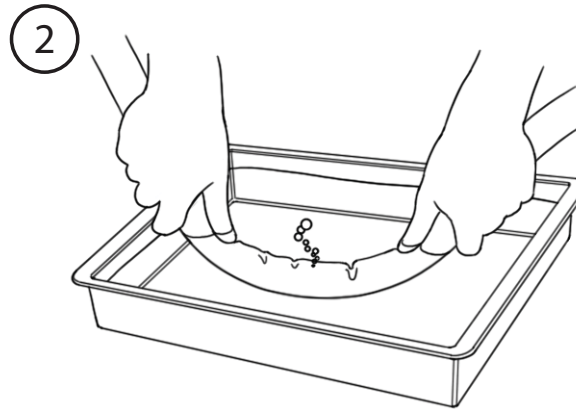

Hold underwater to locate hole

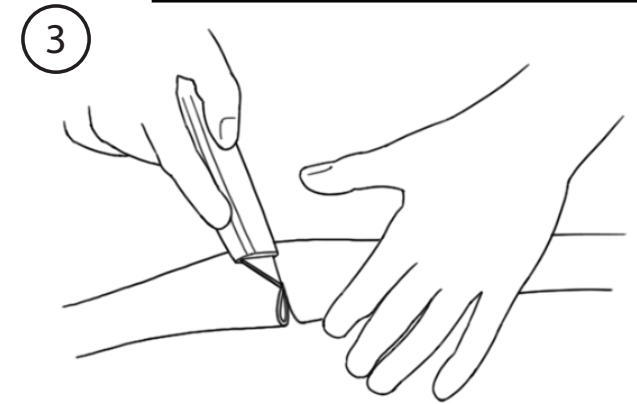

Cut patch from old tube

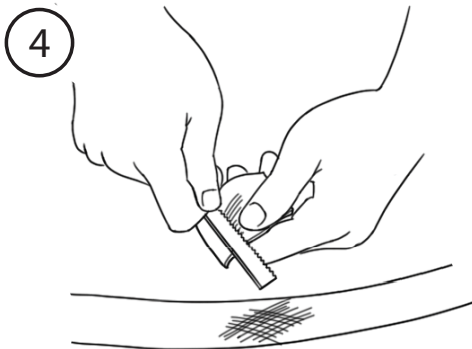

Scratch patch area with hacksaw blade or sandpaper

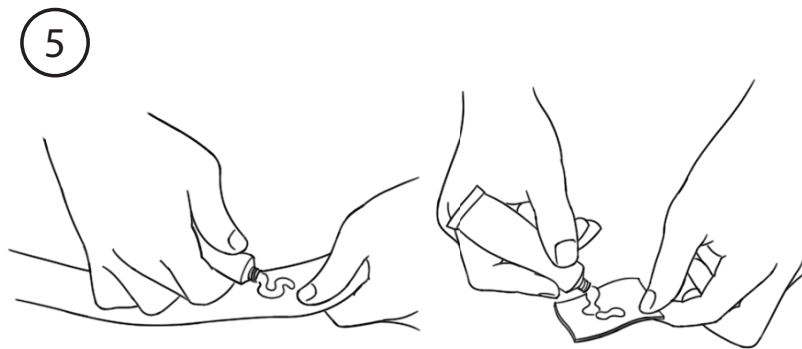

Add patching glue to tube and patch

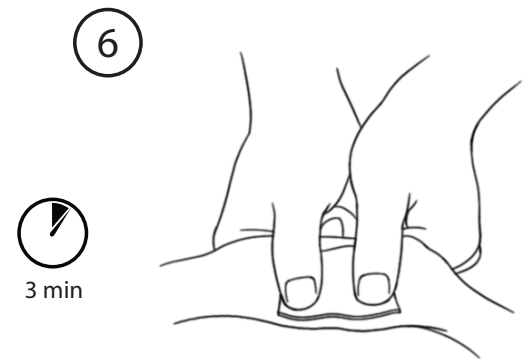

3 min

Press patch down hard on tube



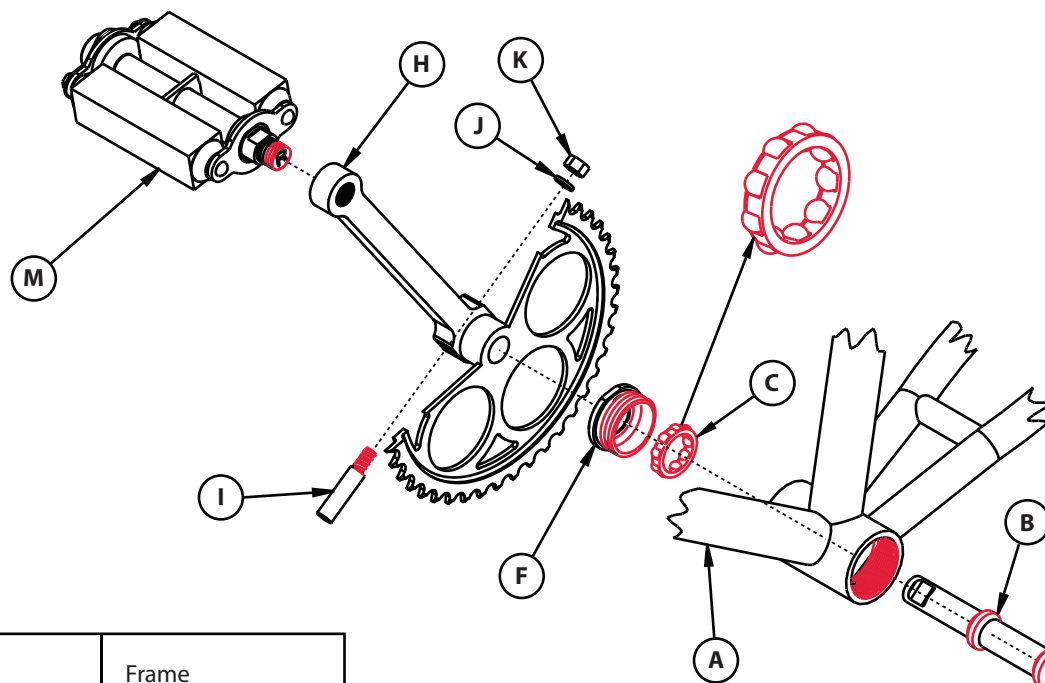

	10mm spanner
	15mm spanner
	26mm spanner
	36mm spanner
	Lockring spanner
	Hammer
	Cotter Anvil







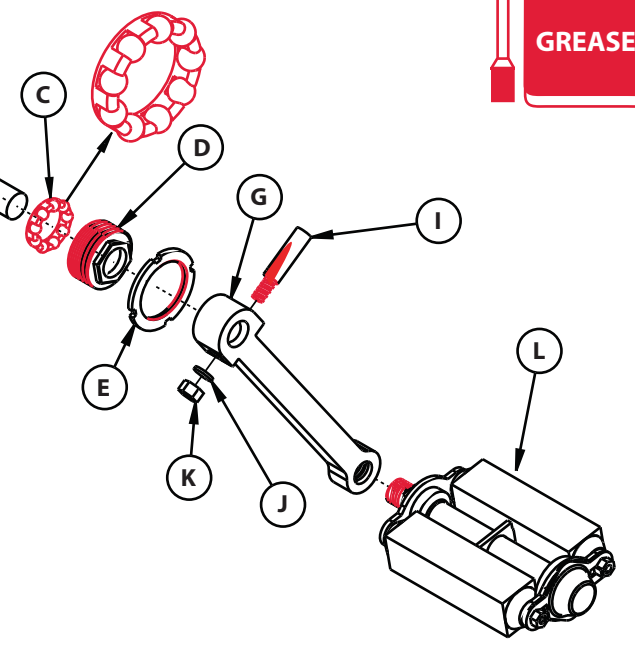



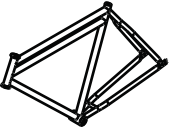
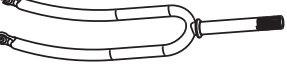

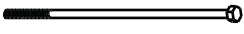

A		Frame
B		BB Spindle
C		BB Bearings (2)
D		Adjustable Cup
E		Lockring
F		Fixed Cup
G		Left Crank Arm

H		Right Crank Arm and Chainring
I		Cotter Pins (2)
J		Cotter Pin Washers (2)
K		Cotter Pin Nuts (2)
L		Left Pedal
M		Right Pedal



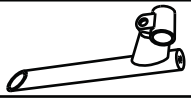

# Bottom Bracket

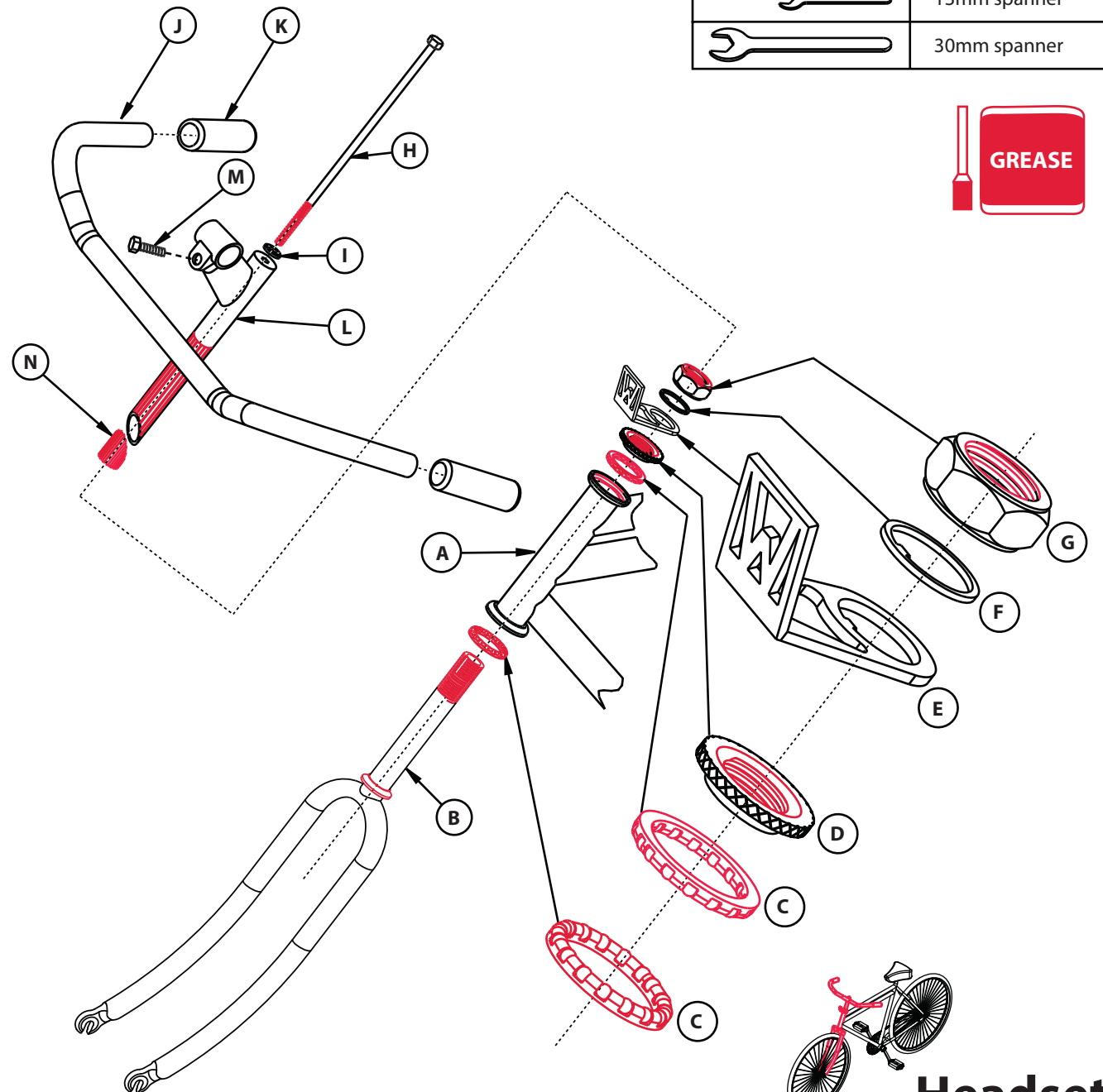
A		Frame
B		Fork
C		Headset Bearing (2)
D		Upper Headset Race
E		Lamp Bracket
F		Headset Spacer
G		Lock Nut
H		Expander Bolt
I		Washer
J		Handlebars
K		Handlebar Grips (2)
L		Stem
M		Stem Bolt
N		Expander Wedge

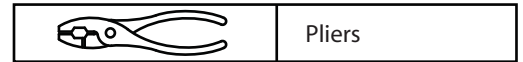
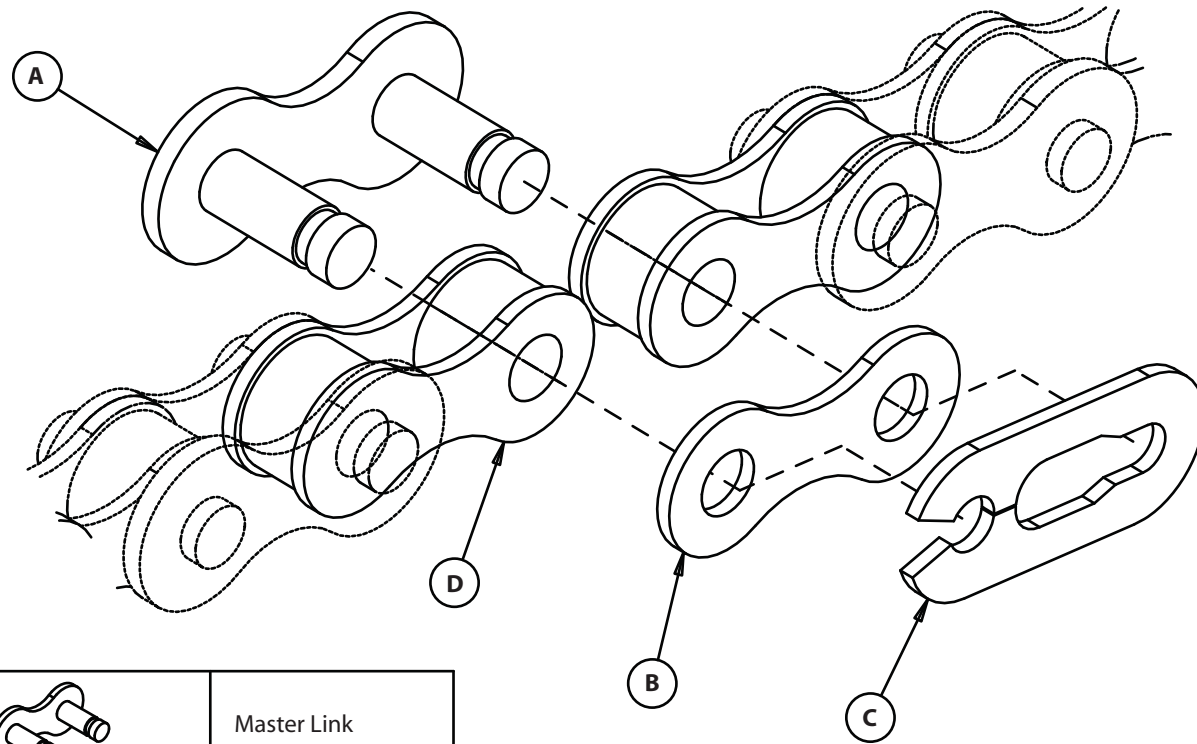



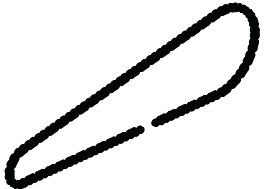

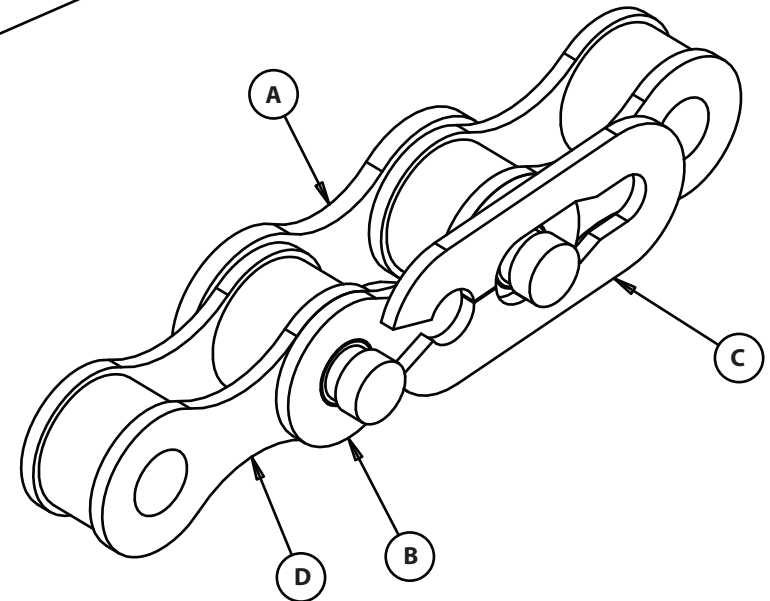

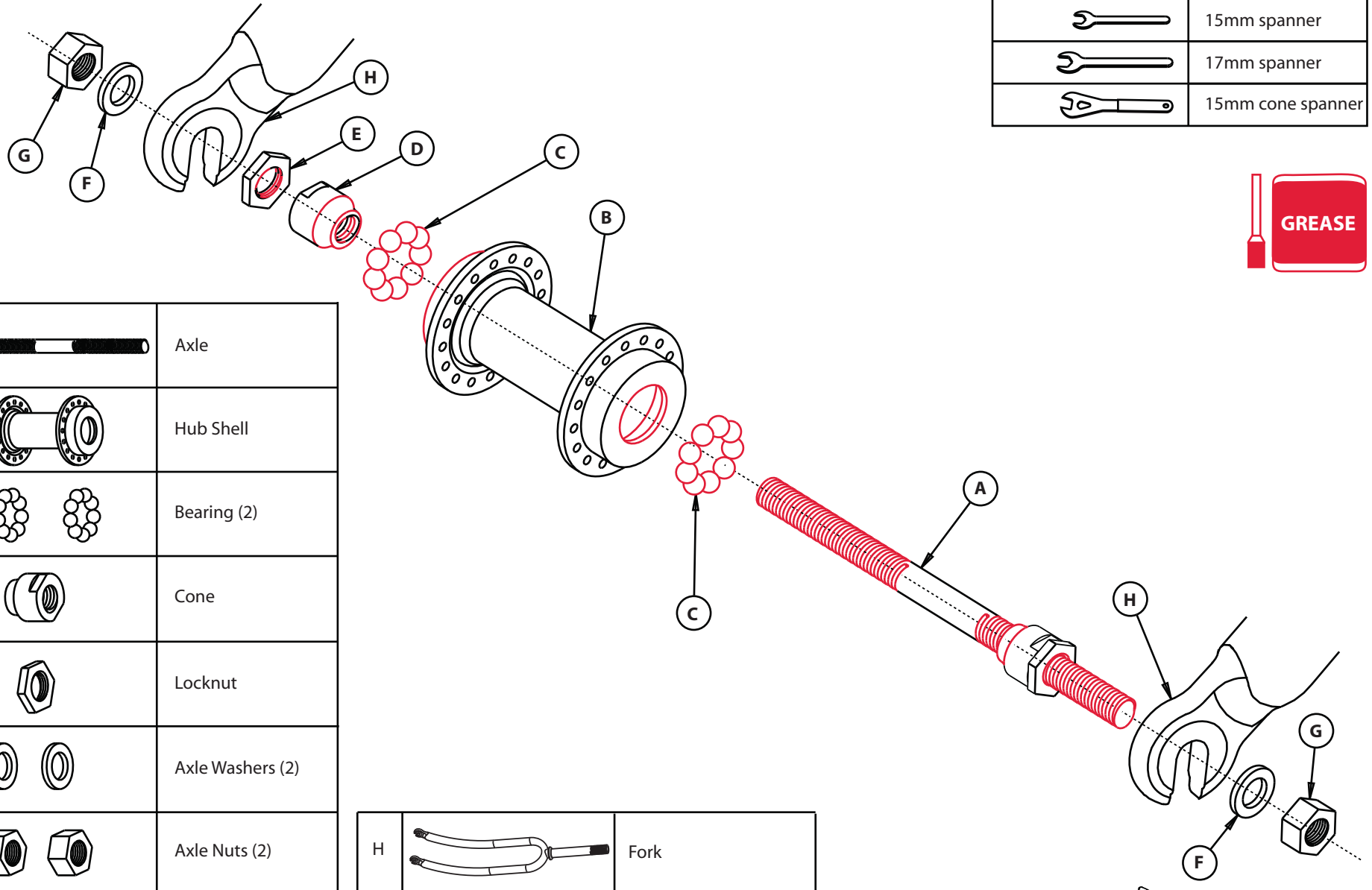

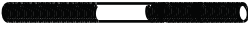
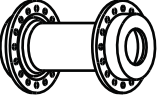
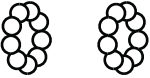

A		Master Link
B		Master Link Side Plate
C		Retaining Clip
D		Chain

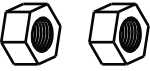

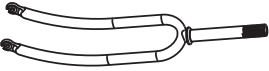

A		Axle
B		Hub Shell
C		Bearing (2)
D		Cone
E		Locknut
F		Axle Washers (2)
G		Axle Nuts (2)

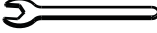
H		Fork
---	--	------

	15mm spanner
	17mm spanner
	15mm cone spanner



# Front Hub

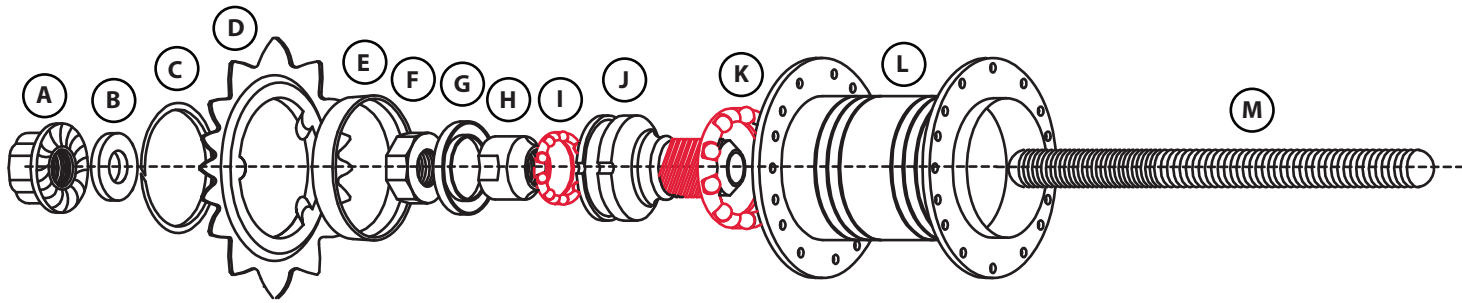

	10mm Spanner
	15mm Spanner
	17mm Spanner
	Screwdriver
	15mm cone spanner

A		Axle Nut (2)
B		Axle Washers (2)
C		Snap Ring
D		Cog
E		Right Dust Cover
F		Lock Nuts (2)
G		Bearing Shield
H		Cone
I		Small Bearing

J		Hub Driver
K		Large Bearings (2)
L		Hub Shell
M		Axle
N		Clutch Cone
O		Clutch Washer
P		Clutch Spring
Q		Spring Holder
R		Brake Shoes

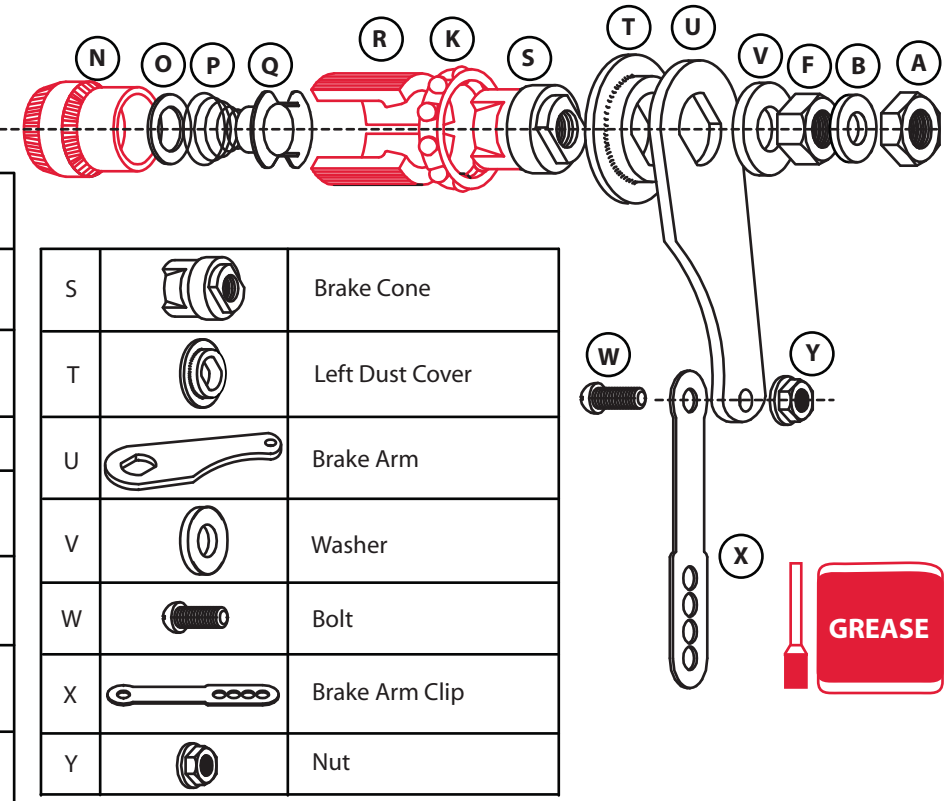

S		Brake Cone
T		Left Dust Cover
U		Brake Arm
V		Washer
W		Bolt
X		Brake Arm Clip
Y		Nut

1

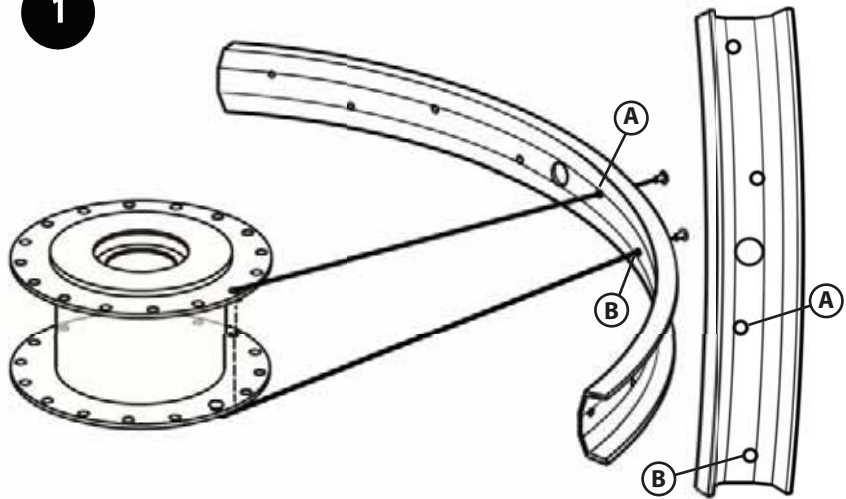

-or-

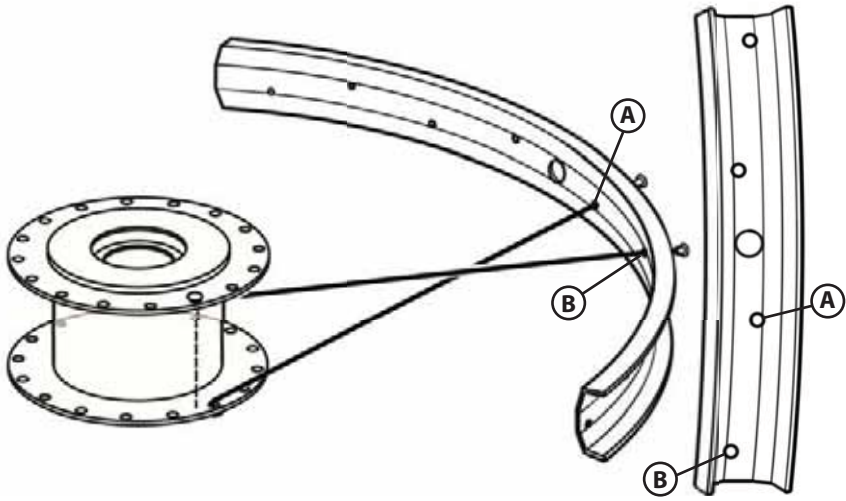

2

# of crossings	Hub holes
4x	10
3x	8
2x	6
1x	4

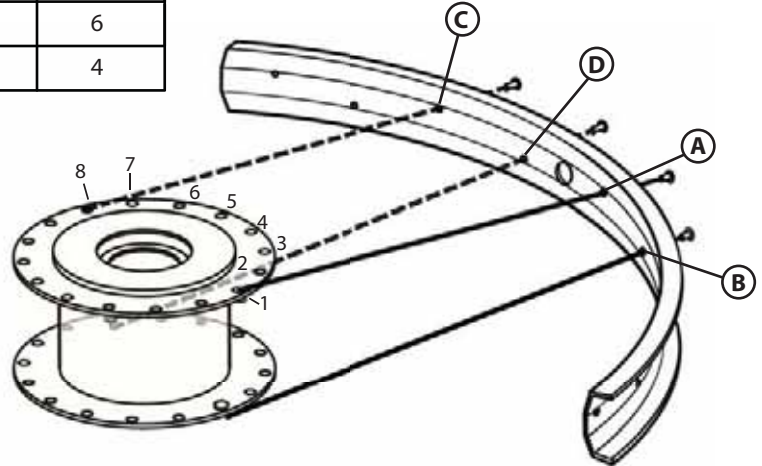

3

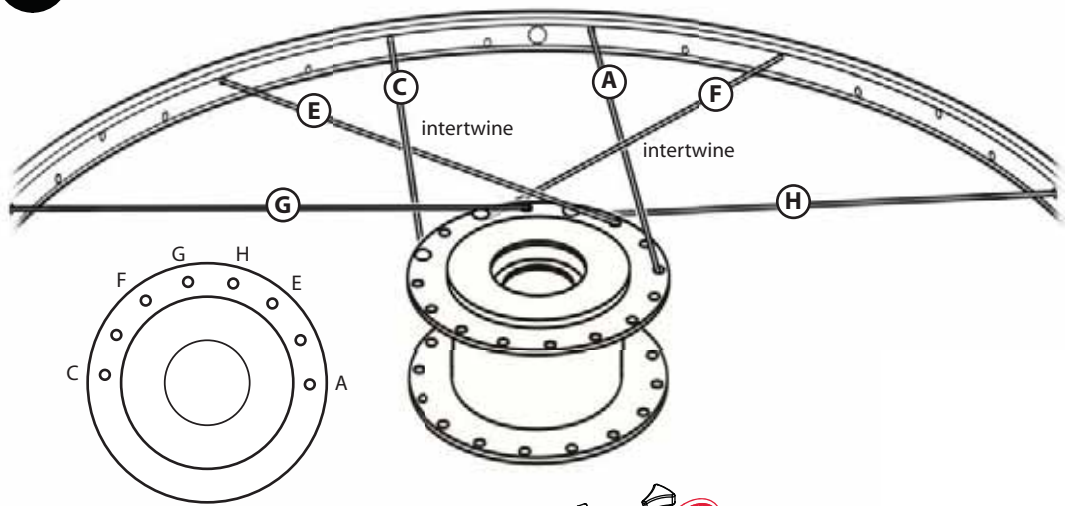



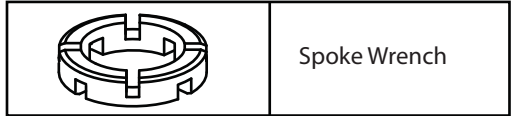

### Truing

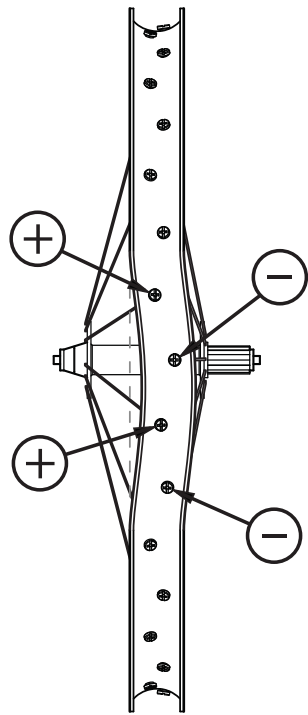

### Rounding

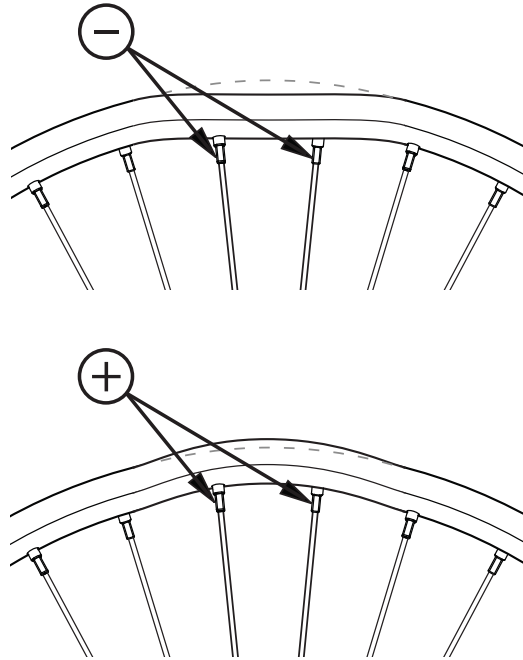

### Dishing

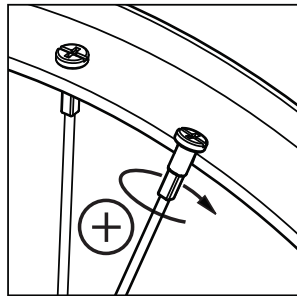
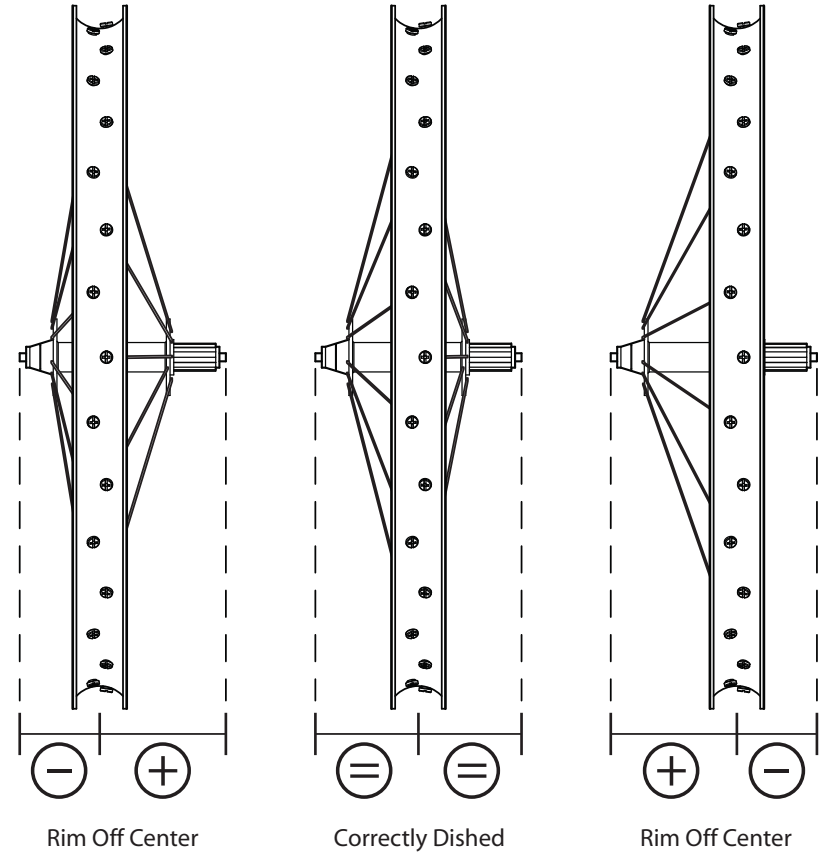

Tighten

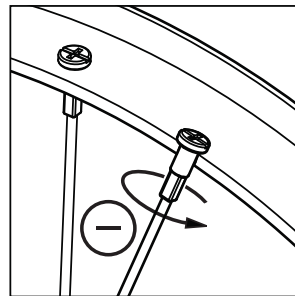

Loosen

